



產品規格書

產品型號 : SL-7.0-800480-ATMN-40

PRODUCT NO. : SL-7.0-800480-ATMN-40

VERSION : Ver 1.0

ISSUED DATE : 2023-03-24

This module uses ROHS material

FOR CUSTOMER : _____

: APPROVAL FOR SPECIFICATION

: APPROVAL FOR SAMPLE

DATE	APPROVED BY

Solonic :

Presented by	Reviewed by	Organized by

Note:

1.Solonic Technology Co.,Ltd. reserves the right to make changes without futher notice to any products hereinto improve reliability, function or design.

2.All rights are reserved. No one is permitted to reproduce or duplicate the whole or part of ths document without Solonic Technology Co., Ltd. permission.

Revision History

Revision	Date	Originator	Detail	Remarks
1.0	20221215		Initial Release	

Table of Contents

No.	Item	Page
1.	General Description	4
2.	Module Parameter	4
2.1.	Outline Drawing	5
3.	Absolute Maximum Ratings	6
4.	DC Characteristics	6
5.	Backlight Characteristics	7
5.1.	Backlight Characteristics	7
5.2.	Backlighting circuit	7
6.	Optical Characteristics	8
6.1.	Optical Characteristics	8
6.2.	Definition of Response Time	8
6.3.	Definition of Contrast Ratio	8
6.4.	Definition of Viewing Angles	9
6.5.	Definition of Color Appearance	8
6.6.	Definition of Surface Luminance, Uniformity and Transmittance	10
7.	Block Diagram and Power Supply	11
8.	Interface Pins Definition	12
9.	AC Characteristics	14
9.1.	AC Timing characteristics	15
9.2.	Display Timing characteristics	15
9.3.	Power ON/Off Sequence	15
10.	Quality Assurance	16
10.1.	Purpose	16
10.2.	Standard for Quality Test	16
10.3.	Nonconforming Analysis & Disposition	16
10.4.	Agreement Items	16
10.5.	Standard of the Product Visual Inspection	16
10.6.	Inspection Specification	17
10.7.	Classification of Defects	21
10.8.	Identification/marketing criteria	21
10.9.	Packing	21
11.	Reliability Specification	22
12.	Precautions and Warranty	23
12.1.	Safety	23
12.2.	Handling	23
12.3.	Storage	23
12.4.	Metal Pin (Apply to Products with Metal Pins)	23
12.5.	Operation	24
12.6.	Static Electricity	24
12.7.	Limited Warranty	24
13.	Packaging	25

1. General Description

The specification is a transmissive type color active matrix liquid crystal display (LCD) which uses amorphous thin film transistor (TFT) as switching devices. This product is composed of a TFT-LCD panel, driver Ics and a backlight unit.

2. Module Parameter

Features	Details	Unit
Display Size(Diagonal)	7.0"	
LCD type	TN TFT	
Display Mode	Transmissive / Normally White	
Resolution	800 RGB x 480	Pixels
View Direction	12 O'CLOCK	Best Image
Gray Scale Inversion Direction	6 O'CLOCK	
Module Outline	164.9(H) x 100(V) x 5.7(T) (Note1)	mm
Active Area	154.08(H) x85.92(V)	mm
Pixel Size	192.6 x179	um
Pixel Arrangement	RGB- island	
Polarizer Surface Treatment	Anti-glare	
Driver IC	EK9713CA&EK73002AB2	
Display Colors	16.7M	
Interface	24bits-RGB Interface	
With or Without Touch Panel	Without	-
Operating Temperature	-20~70	°C
Storage Temperature	-30~80	°C
Weight	-	g

Note 1: Exclusive hooks, posts, FFC/FPC tail etc.

2.1. Outline Drawing

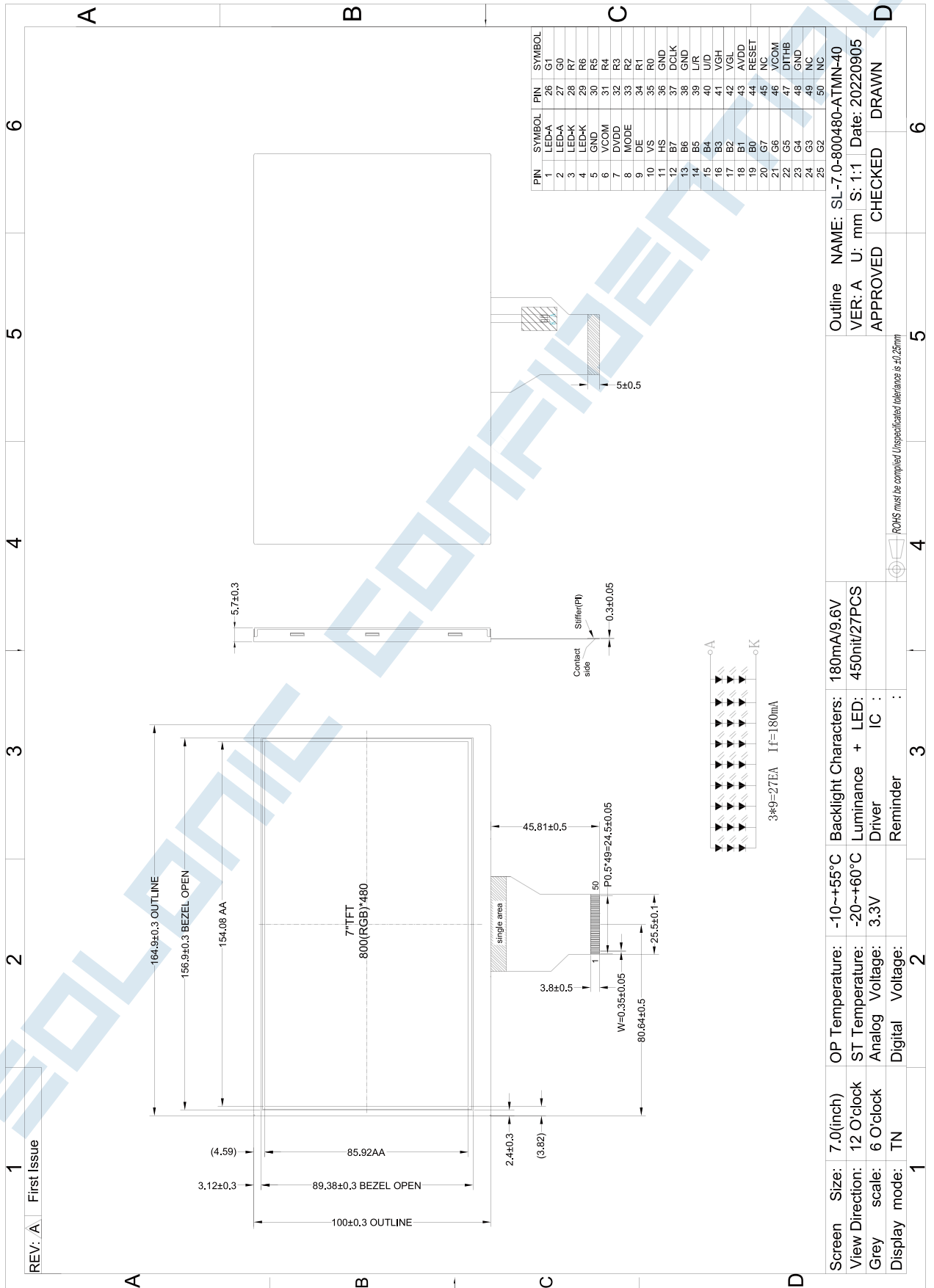

THIS DOCUMENT IS THE SOLE PROPERTY OF **SOLONIC TECHNOLOGY CO., LTD.**
 AND SHOULD NOT BE USED IN WHOLE OR IN PART WITHOUT PRIOR WRITTEN PERMISSION

本文件屬於碩亨科技有限公司獨有財產，未經書面許可不得使用或部分使用

3. Absolute Maximum Ratings

GND=0V, Ta=25°C

Item	Symbol	Min.	Max.	Unit
Supply Voltage	DVDD	-0.3	5.0	V
Storage temperature	T _{STG}	-30	+80	°C
Operating temperature	T _{OP}	-20	+70	°C

Note 1: If Ta below 50°C, the maximal humidity is 90%RH, if Ta over 50°C, absolute humidity should be less than 60%RH.

Note 2: The response time will be extremely slow when the operating temperature is around -10°C, and the back ground will become darker at high temperature operating.

4. DC Characteristics

Item	Symbol	Min.	Typ.	Max.	Unit
	DVDD	3.0	3.3	3.6	V
	AVDD	10.2	10.4	10.6	V
	VGH	14.5	15	15.5	V
	VGL	-10.5	-10	-9.5	V
Common Electrode Driving Signal	VCOM	-	3.6	-	V
Logic Low input voltage	V _{IL}	GND	-	0.3*DVDD	V
Logic High input voltage	V _{IH}	0.7*DVDD	-	DVDD	V

Note 1: Be sure to apply DVDD and VGL to the LCD first, and then apply VGH.

Note 2: DVDD setting should match the signals output voltage (refer to Note 3) of customer's system board.

Note 3: DCLK,HS,VS,RESET,U/D,L/R,DE,R0~R7,G0~G7,B0~B7,MODE,DITHB.

Note 4: Typical VCOM is only a reference value. It must be optimized according to each LCM. Please use VR and base on below application circuit.

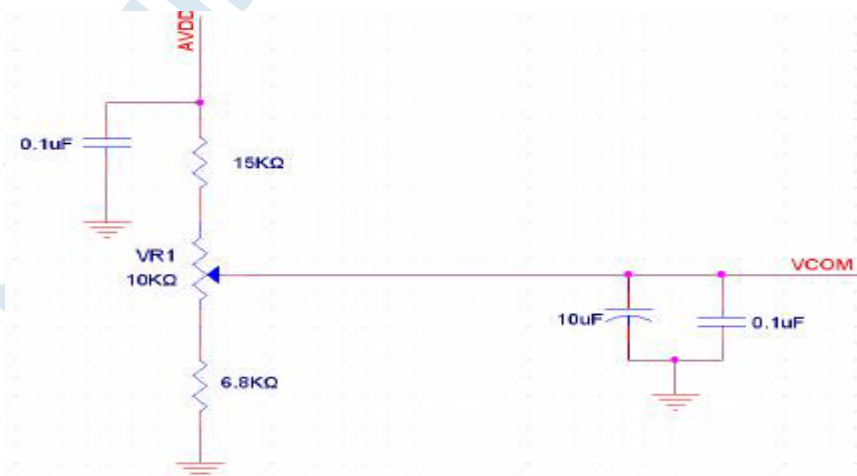

5. Backlight Characteristics

5.1. Backlight Characteristics

Item	Symbol	Condition	Min.	Typ.	Max.	Unit
Backlight Voltage	V _{LED}	T _a =25 °C, I _F =20mA/LED	8.4	9.6	10.2	V
Backlight Current	I _{LED}	T _a =25 °C, V _F =3.2V/LED	-	180	-	mA
Power dissipation	P _D		-	1728	-	mW
Uniformity	Avg		75	80	-	%
LED working life(25°C)	-		20000	30000	-	Hrs
Drive method	Constant current					
LED Configuration	27 White LEDs(3 LEDs in one string and 9 groups in parallel)					

Note1: LED life time defined as follows: The final brightness is at 50% of original brightness.

The environmental conducted under ambient air flow, at T_a=25 ± 2 °C, 60%RH ± 5%, I_F=20mA/LED.

5.2. Backlighting circuit

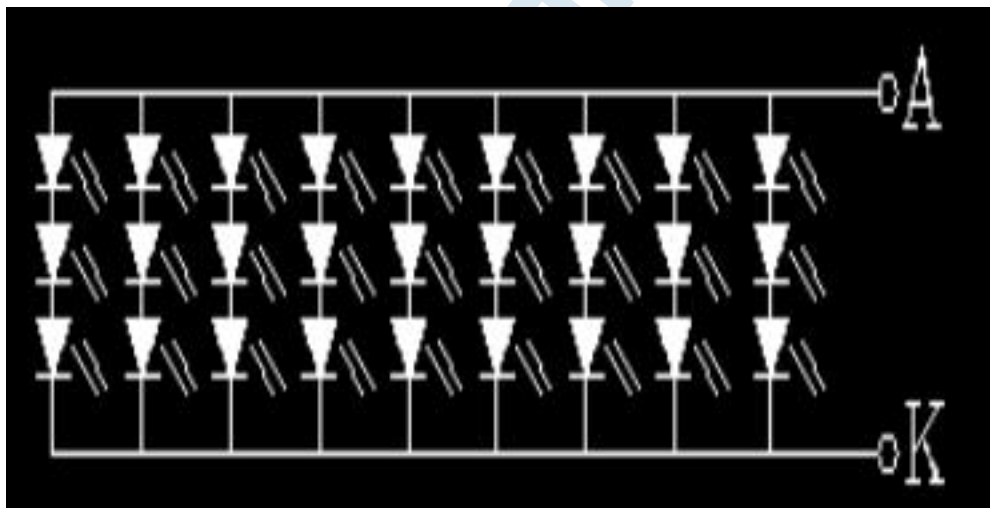

6. Optical Characteristics

6.1. Optical Characteristics

Ta=25°C, DVDD=3.3V

	Item	Symbol	Condition	Specification			Unit	
				Min.	Typ.	Max.		
Backlight On (Transmissive Mode)	Luminance on TFT ($I_f = 20\text{mA/LED}$)	Lv	Normally viewing angle $\theta_x = \phi_y = 0^\circ$	400	450	-	cd/m ²	
	Contrast ratio(See 6.3)	CR		400	500	-		
	Response time (See 6.2)	TR+TF		-	25	50	ms	
	Chromaticity Transmissive (See 6.5)	White		Xw	-	0.291	-	
				Yw	-	0.299	-	
	Viewing Angle (See 6.4)	Horizontal	θ_{x+}	Center CR ≥ 10	60	70	-	Deg.
			θ_{x-}		60	70	-	
Vertical		ϕ_{y+}	40		50	-		
		ϕ_{y-}	60		70	-		
NTSC Ratio(Gamut)			-	52	-	%		

6.2. Definition of Response Time

6.2.1. Normally Black Type (Negative)

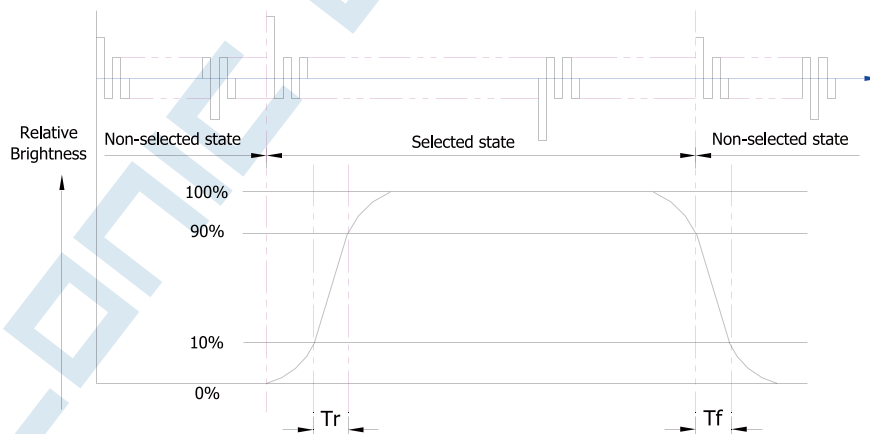

Tr is the time it takes to change from non-selected stage with relative luminance 10% to selected state with relative luminance 90%;

Tf is the time it takes to change from selected state with relative luminance 90% to non-selected state with relative luminance 10%

Note: Measuring machine: LCD-5100

6.2.2. Normally White Type (Positive)

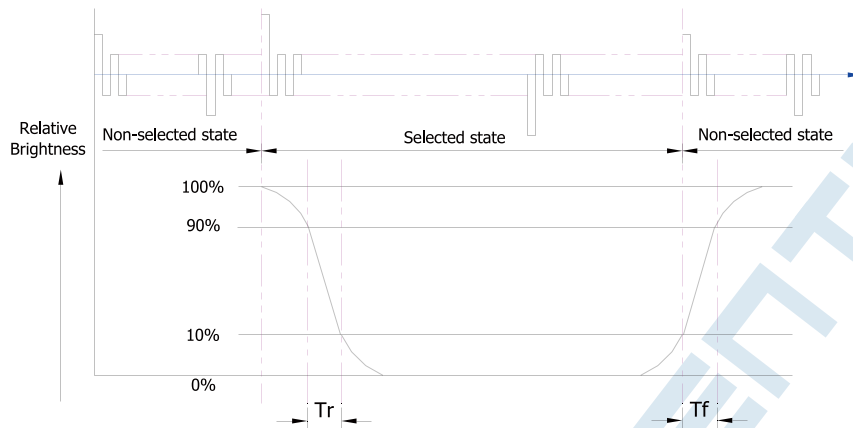

Tr is the time it takes to change from non-selected stage with relative luminance 90% to selected state with relative luminance 10%;

Tf is the time it takes to change from selected state with relative luminance 10% to non-selected state with relative luminance 90%;

Note: Measuring machine: LCD-5100 or EQUI

6.3. Definition of Contrast Ratio

Contrast is measured perpendicular to display surface in reflective and transmissive mode. The measurement condition is:

Measuring Equipment	Eldim or Equivalent
Measuring Point Diameter	3mm//1mm
Measuring Point Location	Active Area centre point
Test pattern	A: All Pixels white
	B: All Pixel black
Contrast setting	Maximum

Definitions: CR (Contrast) = Luminance of White Pixel / Luminance of Black Pixel

6.4. Definition of Viewing Angles

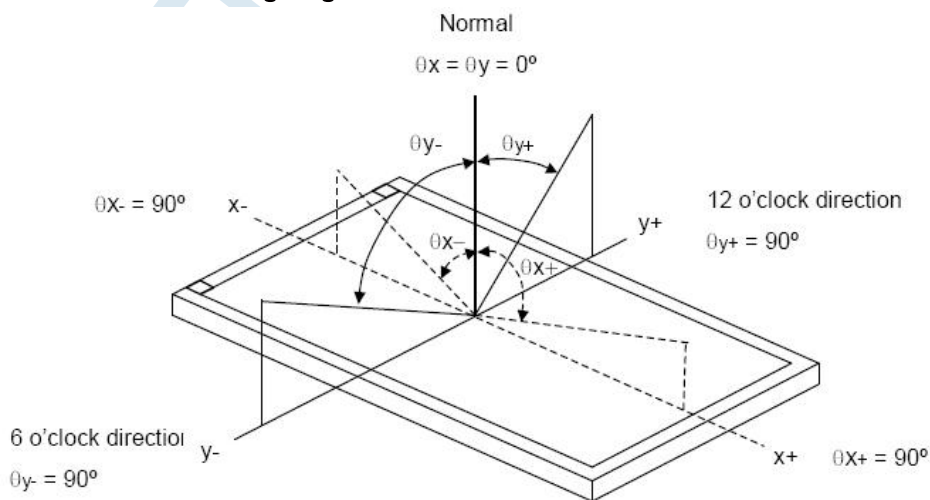

Measuring machine: LCD-5100 or EQUI

6.5. Definition of Color Appearance

R,G,B and W are defined by (x, y) on the IE chromaticity diagram

THIS DOCUMENT IS THE SOLE PROPERTY OF **SOLONIC TECHNOLOGY CO., LTD.**
 AND SHOULD NOT BE USED IN WHOLE OR IN PART WITHOUT PRIOR WRITTEN PERMISSION

本文件屬於碩享科技有限公司獨有財產，未經書面許可不得使用或部分使用

NTSC=area of RGB triangle/area of NTSC triangleX100%

Measuring picture: Red, Green, Blue and White (Measuring machine: BM-7)

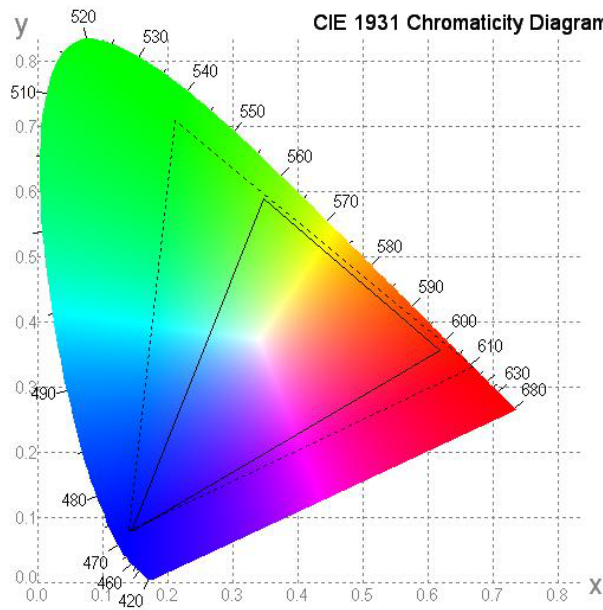

6.6. Definition of Surface Luminance, Uniformity and Transmittance

Using the transmissive mode measurement approach, measure the white screen luminance of the display panel and backlight.

6.6.1. Surface Luminance: $L_V = \text{average} (L_{P1}:L_{P9})$

6.6.2. Uniformity = Minimal ($L_{P1}:L_{P9}$) / Maximal ($L_{P1}:L_{P9}$) * 100%

6.6.3. Transmittance = $L_V \text{ on LCD} / L_V \text{ on Backlight} * 100\%$

Note: Measuring machine: BM-7

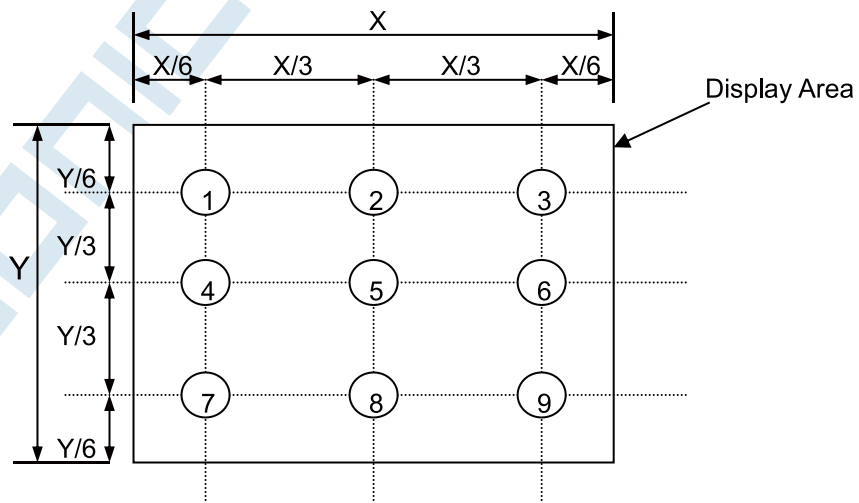

7. Block Diagram and Power Supply

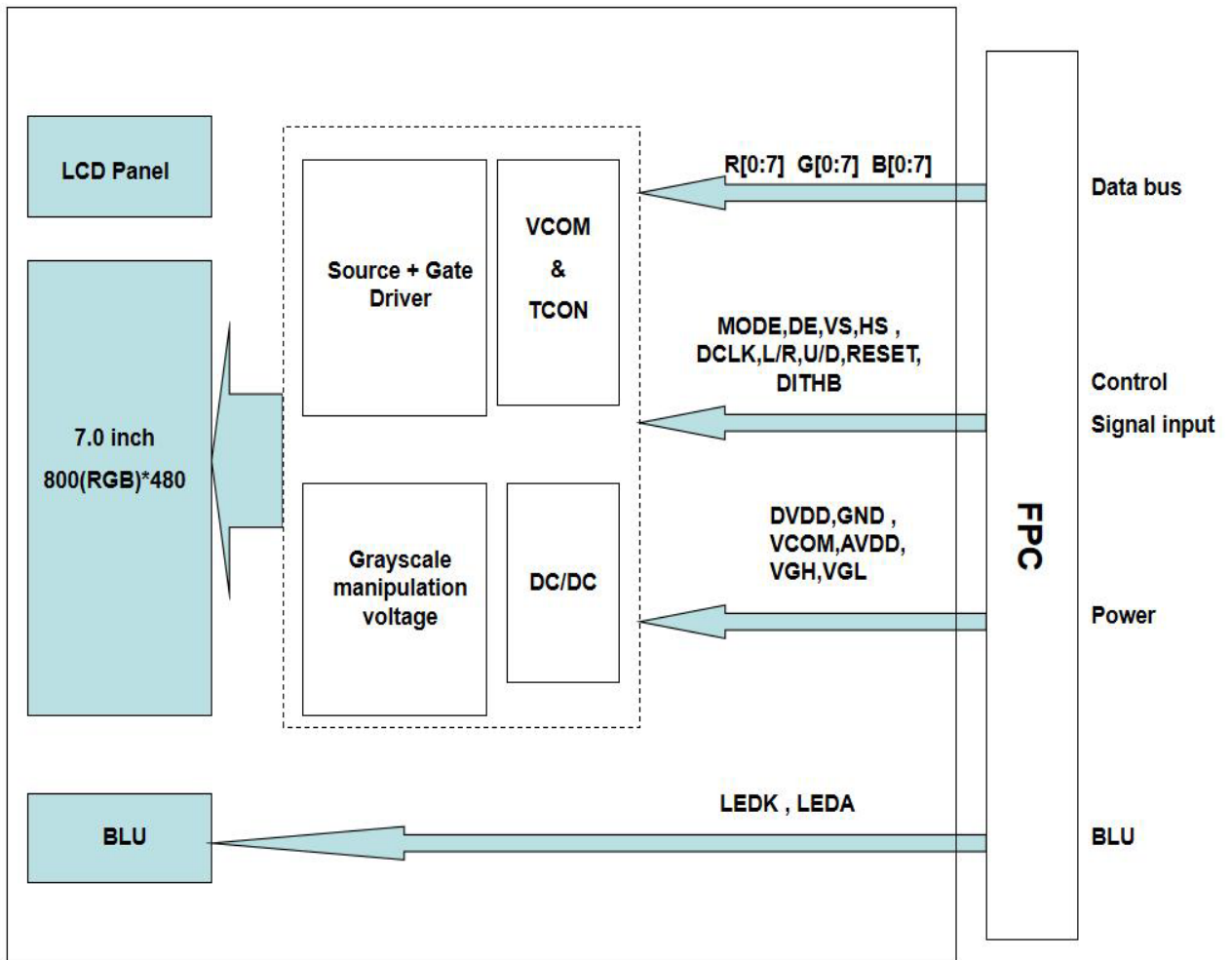

8. Interface Pins Definition

No.	Symbol	Function	Remark
1	VLED+	LED Input Terminal I(Anode).	
2	VLED+	LED Input Terminal I(Anode).	
3	VLED-	Ground (Cathode).	
4	VLED-	Ground (Cathode).	
5	GND	Ground.	
6	VCOM	Common voltage.	
7	DVDD	Power for Digital Circuit.	
8	MODE	DE/SYNC mode select.	Note 1
9	DE	Data Input Enable.	
10	VS	Vertical Sync Input.	
11	HS	Horizontal Sync Input.	
12	B7	Blue data(MSB)	
13	B6	Blue data	
14	B5	Blue data	
15	B4	Blue data	
16	B3	Blue data	
17	B2	Blue data	
18	B1	Blue data	Note 2
19	B0	Blue data(LSB)	Note 2
20	G7	Green data(MSB)	
21	G6	Green data	
22	G5	Green data	
23	G4	Green data	
24	G3	Green data	
25	G2	Green data	
26	G1	Green data	Note 2
27	G0	Green data(LSB)	Note 2
28	R7	Red data(MSB)	
29	R6	Red data	
30	R5	Red data	
31	R4	Red data	
32	R3	Red data	
33	R2	Red data	
34	R1	Red data	Note 2
35	R0	Red data(LSB)	Note 2
36	GND	Ground.	
37	DCLK	Sample clock.	Note 3
38	GND	Ground.	
39	L/R	Left / right selection.	Note 4,5
40	U/D	Up / Down selection.	Note 4,5
41	VGH	Gate ON Voltage.	

THIS DOCUMENT IS THE SOLE PROPERTY OF **SOLONIC TECHNOLOGY CO., LTD.**
 AND SHOULD NOT BE USED IN WHOLE OR IN PART WITHOUT PRIOR WRITTEN PERMISSION

本文件屬於碩享科技有限公司獨有財產，未經書面許可不得使用或部分使用

42	VGL	Gate OFF Voltage.	
43	AVDD	Power for Analog Circuit.	
44	RESET	Global reset pin.	Note 6
45	NC	No connection.	
46	VCOM	Common voltage.	Note 7
47	DITHB	Dithering function.	
48	GND	Ground.	
49	NC	No connection.	
50	NC	No connection.	

Setting of scan control input		Scanning direction
U/D	L/R	
GND	DVDD	Up to down, left to right
DVDD	GND	Down to up, right to left
GND	GND	Up to down, right to left
DVDD	DVDD	Down to up, left to right

Note 1: Definition of scanning direction.

Refer to the figure as follow:

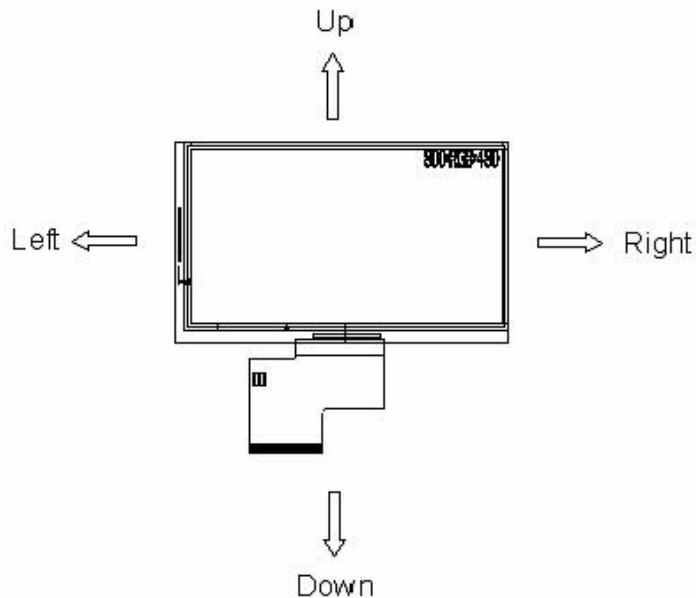

Note 2: Global reset pin. Active low to enter reset state. Suggest to connect with and RC reset circuit for stability. Normally pull high.

Note 3: Dithering function enable control, normally pull high.
 When DITHB="1", Disable internal dithering function.
 When DITHB="0", Enable internal dithering function.

THIS DOCUMENT IS THE SOLE PROPERTY OF **SOLONIC TECHNOLOGY CO., LTD.**
 AND SHOULD NOT BE USED IN WHOLE OR IN PART WITHOUT PRIOR WRITTEN PERMISSION

本文件屬於碩享科技有限公司獨有財產，未經書面許可不得使用或部分使用

9. AC Characteristics

9.1. Timing Characteristics of input signals

Parameter	Symbol	Spec.			Unit
		Min.	typ.	Max.	
HS setup time	T_{hst}	8	-	-	ns
HS hold time	T_{hhd}	8	-	-	ns
VS setup time	T_{vst}	8	-	-	ns
VS hold time	T_{vhd}	8	-	-	ns
Data setup time	T_{dsu}	8	-	-	ns
Data hold time	T_{dhd}	8	-	-	ns
DE setup time	T_{esu}	8	-	-	ns
DE hold time	T_{ehd}	8	-	-	ns
VDD Power On Slew rate	T_{POR}	-	-	20	ms
RSTB pulse width	T_{Rst}	10	-	-	us
CLKIN cycle time	T_{cph}	20	-	-	ns
CLKIN pulse duty	T_{cwh}	40	50	60	%
Output stable time	T_{sst}	-	-	6	us

9.2. Data Input format



Horizontal input timing diagram

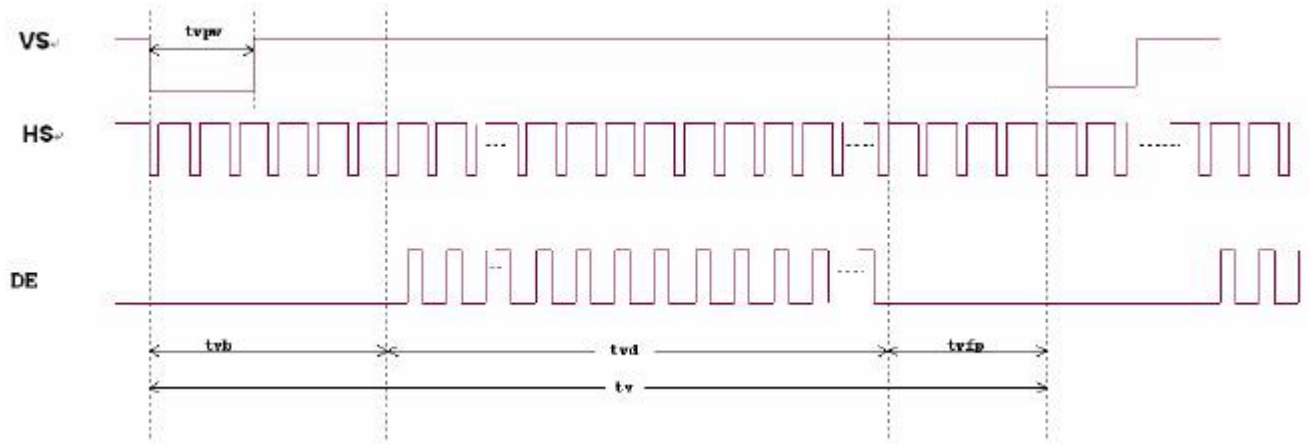

Vertical input timing diagram

9.3. Timing

Item	Symbol	Values			Unit	Remark
		Min.	Typ.	Max.		
Horizontal Display Area	thd	--	800	--	DCLK	
DCLK Frequency	fclk	26.4	33.3	46.8	MHz	
One Horizontal Line	th	862	1056	1200	DCLK	
HS Pulse Width	thpw	1	--	40	DCLK	
HS Blanking	thb	46	46	46	DCLK	
HS Front Porch	thfp	16	210	354	DCLK	

Item	Symbol	Values			Unit	Remark
		Min.	Typ.	Max.		
Vertical Display Area	tvd	--	480	--	TH	
VS Period Time	tv	510	525	650	TH	
VS Pulse Width	tvpw	1	--	20	TH	
VS Blanking	tvb	23	23	23	TH	
VS Front Porch	tvfp	7	22	147	TH	

10. Quality Assurance

10.1. Purpose

This standard for Quality Assurance assures the quality of LCD module products supplied to customer.

10.2. Standard for Quality Test

10.2.1. Sampling Plan:

GB2828.1-2012

Single sampling, general inspection level II

10.2.2. Sampling Criteria:

Visual inspection: AQL 1.5

Electrical functional: AQL 0.65.

10.2.3. Reliability Test:

Detailed requirement refer to Reliability Test Specification.

10.3. Nonconforming Analysis & Disposition

10.3.1. Nonconforming analysis:

10.3.1.1. Customer should provide overall information of non-conforming sample for their complaints.

10.3.1.2. After receipt of detailed information from customer, the analysis of nonconforming parts usually should be finished in one week.

10.3.1.3. If cannot finish the analysis on time, customer will be notified with the progress status.

10.3.2. Disposition of nonconforming:

10.3.2.1. Non-conforming product over PPM level will be replaced.

10.3.2.2. The cause of non-conformance will be analyzed. Corrective action will be discussed and implemented.

10.4. Agreement Items

Shall negotiate with customer if the following situation occurs:

10.4.1. There is any discrepancy in standard of quality assurance.

10.4.2. Additional requirement to be added in product specification.

10.4.3. Any other special problem.

10.5. Standard of the Product Visual Inspection

10.5.1. Appearance inspection:

10.5.1.1. The inspection must be under illumination about 1000 – 1500 lx, and the distance of view must be at 30cm ± 2cm.

10.5.1.2. The viewing angle should be 45° from the vertical line without reflection light or follows customer's viewing angle specifications.

10.5.1.3. Definition of area: A Zone: Active Area, B Zone: Viewing Area,

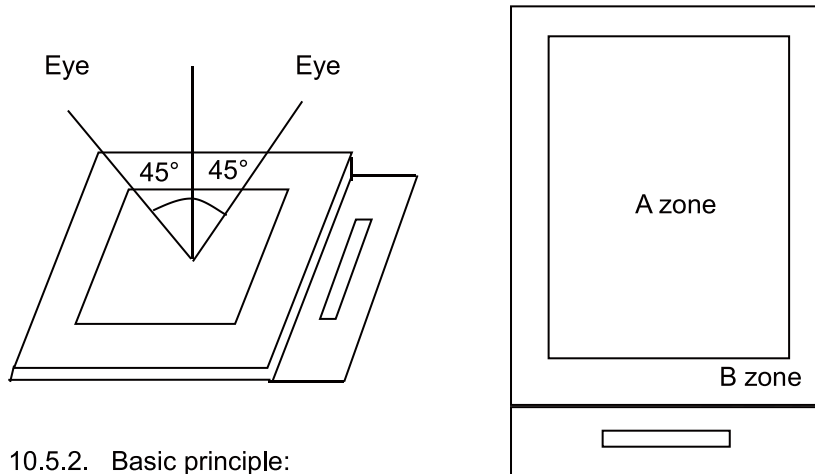

10.5.2. Basic principle:

10.5.2.1. A set of sample to indicate the limit of acceptable quality level must be discussed by both us and customer when there is any dispute happened.

10.5.2.2. New item must be added on time when it is necessary.

10.6. Inspection Specification

No.	Item	Criteria (Unit: mm)																
01	Black / White spot Foreign material (Round type) Pinholes Stain Particles inside cell. (Minor defect)	<div style="display: flex; justify-content: space-around; align-items: center;"> <table border="1" style="border-collapse: collapse;"> <thead> <tr> <th>Size</th> <th>Area</th> <th>Acc. Qty</th> </tr> </thead> <tbody> <tr> <td>$\phi \leq 0.20$</td> <td></td> <td>Ignore</td> </tr> <tr> <td>$0.20 < \phi \leq 0.50$</td> <td></td> <td>$N \leq 3$</td> </tr> <tr> <td>$0.50 < \phi$</td> <td></td> <td>0</td> </tr> </tbody> </table> </div> <p>$\phi = (a + b) / 2$ Distance between 2 defects should more than 5mm apart.</p>	Size	Area	Acc. Qty	$\phi \leq 0.20$		Ignore	$0.20 < \phi \leq 0.50$		$N \leq 3$	$0.50 < \phi$		0				
Size	Area	Acc. Qty																
$\phi \leq 0.20$		Ignore																
$0.20 < \phi \leq 0.50$		$N \leq 3$																
$0.50 < \phi$		0																
02	Electrical Defect (Minor defect)	<table border="1" style="width: 100%; border-collapse: collapse;"> <thead> <tr> <th rowspan="2">Bright dot</th> <th>Display Area</th> <th>Total</th> <th rowspan="3">Note 1</th> </tr> </thead> <tbody> <tr> <td>$N \leq 2$</td> <td>$N \leq 2$</td> </tr> <tr> <th>Dark dot</th> <td>$N \leq 4$</td> <td>$N \leq 4$</td> </tr> <tr> <th>Total dot</th> <td>$N \leq 4$</td> <td>$N \leq 4$</td> </tr> <tr> <th>Mura</th> <td colspan="2">Not visible through 5% ND filters.</td> <td>Note 2</td> </tr> </tbody> </table> <p>Remark: 1. Bright dot caused by scratch and foreign object accords to item 1.</p>	Bright dot	Display Area	Total	Note 1	$N \leq 2$	$N \leq 2$	Dark dot	$N \leq 4$	$N \leq 4$	Total dot	$N \leq 4$	$N \leq 4$	Mura	Not visible through 5% ND filters.		Note 2
Bright dot	Display Area	Total		Note 1														
	$N \leq 2$	$N \leq 2$																
Dark dot	$N \leq 4$	$N \leq 4$																
Total dot	$N \leq 4$	$N \leq 4$																
Mura	Not visible through 5% ND filters.		Note 2															

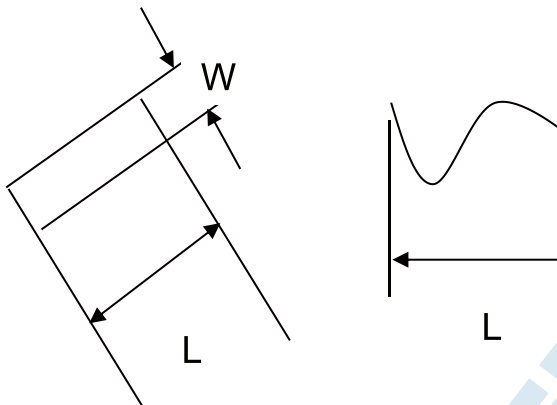
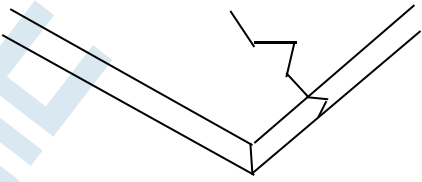
03	Black and White line Scratch Foreign material (Line type) (Minor defect)	 <table border="1" data-bbox="595 721 1222 983"> <thead> <tr> <th>Length</th> <th>Width</th> <th>Acc. Qty</th> </tr> </thead> <tbody> <tr> <td>/</td> <td>$W \leq 0.1$</td> <td>Ignore</td> </tr> <tr> <td>$L \leq 2.5$</td> <td>$0.1 < W \leq 0.2$</td> <td>3</td> </tr> <tr> <td>$L > 2.5$</td> <td>$0.2 < W$</td> <td>0</td> </tr> <tr> <td colspan="2">Total</td> <td>3</td> </tr> </tbody> </table> <p data-bbox="534 1032 1445 1104">Distance between 2 defects should more than 3mm apart. Scratches not viewable through the back of the display are acceptable.</p>	Length	Width	Acc. Qty	/	$W \leq 0.1$	Ignore	$L \leq 2.5$	$0.1 < W \leq 0.2$	3	$L > 2.5$	$0.2 < W$	0	Total		3
Length	Width	Acc. Qty															
/	$W \leq 0.1$	Ignore															
$L \leq 2.5$	$0.1 < W \leq 0.2$	3															
$L > 2.5$	$0.2 < W$	0															
Total		3															
04	Glass Crack (Minor defect)	 <p data-bbox="534 1433 1161 1464">Crack is potential to enlarge, any type is not allowed.</p>															

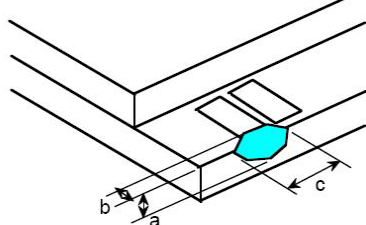
05	Glass Chipping Pad Area: (Minor defect)	 <table border="1" data-bbox="896 1635 1367 1809"> <thead> <tr> <th>Length and Width</th> <th>Acc. Qty</th> </tr> </thead> <tbody> <tr> <td>$c > 3.0, b < 1.0$</td> <td>1</td> </tr> <tr> <td>$c < 3.0, b < 1.0$</td> <td>3</td> </tr> <tr> <td colspan="2">$a < \text{Glass Thickness}$</td> </tr> </tbody> </table>	Length and Width	Acc. Qty	$c > 3.0, b < 1.0$	1	$c < 3.0, b < 1.0$	3	$a < \text{Glass Thickness}$	
Length and Width	Acc. Qty									
$c > 3.0, b < 1.0$	1									
$c < 3.0, b < 1.0$	3									
$a < \text{Glass Thickness}$										

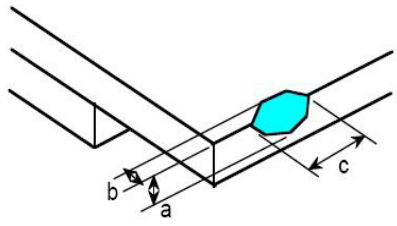
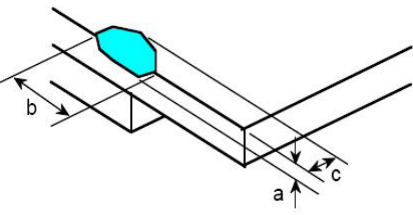
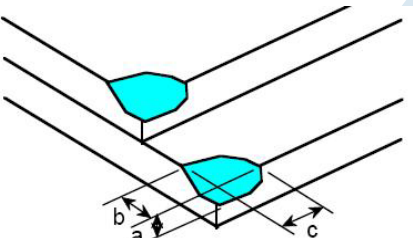
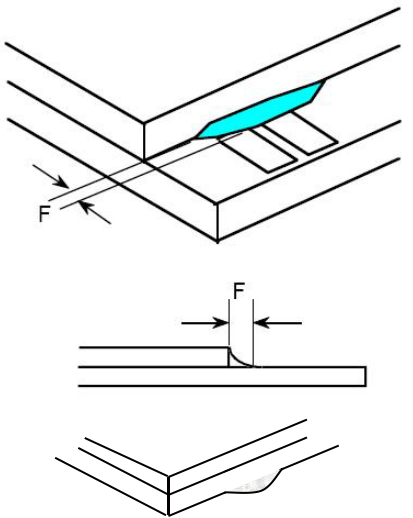
<p>06</p>	<p>Glass Chipping Rear of Pad Area: (Minor defect)</p> 	<table border="1"> <thead> <tr> <th>Length and Width</th> <th>Acc. Qty</th> </tr> </thead> <tbody> <tr> <td>$c > 3.0, b < 1.0$</td> <td>1</td> </tr> <tr> <td>$c < 3.0, b < 1.0$</td> <td>2</td> </tr> <tr> <td>$c < 3.0, b < 0.5$</td> <td>4</td> </tr> <tr> <td colspan="2" style="text-align: center;">$a < \text{Glass Thickness}$</td> </tr> </tbody> </table>	Length and Width	Acc. Qty	$c > 3.0, b < 1.0$	1	$c < 3.0, b < 1.0$	2	$c < 3.0, b < 0.5$	4	$a < \text{Glass Thickness}$	
Length and Width	Acc. Qty											
$c > 3.0, b < 1.0$	1											
$c < 3.0, b < 1.0$	2											
$c < 3.0, b < 0.5$	4											
$a < \text{Glass Thickness}$												
<p>07</p>	<p>Glass Chipping Except Pad Area: (Minor defect)</p> 	<table border="1"> <thead> <tr> <th>Length and Width</th> <th>Acc. Qty</th> </tr> </thead> <tbody> <tr> <td>$c > 3.0, b < 1.0$</td> <td>1</td> </tr> <tr> <td>$c < 3.0, b < 1.0$</td> <td>2</td> </tr> <tr> <td>$c < 3.0, b < 0.5$</td> <td>4</td> </tr> <tr> <td colspan="2" style="text-align: center;">$a < \text{Glass Thickness}$</td> </tr> </tbody> </table>	Length and Width	Acc. Qty	$c > 3.0, b < 1.0$	1	$c < 3.0, b < 1.0$	2	$c < 3.0, b < 0.5$	4	$a < \text{Glass Thickness}$	
Length and Width	Acc. Qty											
$c > 3.0, b < 1.0$	1											
$c < 3.0, b < 1.0$	2											
$c < 3.0, b < 0.5$	4											
$a < \text{Glass Thickness}$												
<p>08</p>	<p>Glass Corner Chipping: (Minor defect)</p> 	<table border="1"> <thead> <tr> <th>Length and Width</th> <th>Acc. Qty</th> </tr> </thead> <tbody> <tr> <td>$c < 3.0, b < 3.0$</td> <td>Ignore</td> </tr> <tr> <td colspan="2" style="text-align: center;">$a < \text{Glass Thickness}$</td> </tr> </tbody> </table>	Length and Width	Acc. Qty	$c < 3.0, b < 3.0$	Ignore	$a < \text{Glass Thickness}$					
Length and Width	Acc. Qty											
$c < 3.0, b < 3.0$	Ignore											
$a < \text{Glass Thickness}$												
<p>09</p>	<p>Glass Burr: (Minor defect)</p> 	<table border="1"> <thead> <tr> <th>Length</th> <th>Acc. Qty</th> </tr> </thead> <tbody> <tr> <td>$F < 1.0$</td> <td>Ignore</td> </tr> </tbody> </table> <p>Glass burr don't affect assemble and module dimension.</p>	Length	Acc. Qty	$F < 1.0$	Ignore						
Length	Acc. Qty											
$F < 1.0$	Ignore											

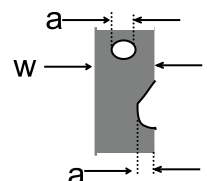
10	FPC Defect: (Minor defect)		10.1 Dent, pinhole width $a < w/3$. (w: circuitry width.) 10.2 Open circuit is unacceptable. 10.3 No oxidation, contamination and distortion.								
11	Bubble on Polarizer (Minor defect)	<table border="1" style="margin: auto;"> <thead> <tr> <th style="padding: 5px;">Diameter</th> <th style="padding: 5px;">Acc. Qty</th> </tr> </thead> <tbody> <tr> <td style="text-align: center; padding: 5px;">$\phi \leq 0.30$</td> <td style="text-align: center; padding: 5px;">Ignore</td> </tr> <tr> <td style="text-align: center; padding: 5px;">$0.30 < \phi \leq 0.50$</td> <td style="text-align: center; padding: 5px;">$N \leq 2$</td> </tr> <tr> <td style="text-align: center; padding: 5px;">$0.50 < \phi$</td> <td style="text-align: center; padding: 5px;">$N = 0$</td> </tr> </tbody> </table>		Diameter	Acc. Qty	$\phi \leq 0.30$	Ignore	$0.30 < \phi \leq 0.50$	$N \leq 2$	$0.50 < \phi$	$N = 0$
Diameter	Acc. Qty										
$\phi \leq 0.30$	Ignore										
$0.30 < \phi \leq 0.50$	$N \leq 2$										
$0.50 < \phi$	$N = 0$										
12	Dent on Polarizer (Minor defect)	<table border="1" style="margin: auto;"> <thead> <tr> <th style="padding: 5px;">Diameter</th> <th style="padding: 5px;">Acc. Qty</th> </tr> </thead> <tbody> <tr> <td style="text-align: center; padding: 5px;">$\phi \leq 0.25$</td> <td style="text-align: center; padding: 5px;">Ignore</td> </tr> <tr> <td style="text-align: center; padding: 5px;">$0.25 < \phi \leq 0.50$</td> <td style="text-align: center; padding: 5px;">$N \leq 4$</td> </tr> <tr> <td style="text-align: center; padding: 5px;">$0.50 < \phi$</td> <td style="text-align: center; padding: 5px;">None</td> </tr> </tbody> </table>		Diameter	Acc. Qty	$\phi \leq 0.25$	Ignore	$0.25 < \phi \leq 0.50$	$N \leq 4$	$0.50 < \phi$	None
Diameter	Acc. Qty										
$\phi \leq 0.25$	Ignore										
$0.25 < \phi \leq 0.50$	$N \leq 4$										
$0.50 < \phi$	None										
13	Bezel	13.1 No rust, distortion on the Bezel. 13.2 No visible fingerprints, stains or other contamination.									
14	Touch Panel	D: Diameter W: width L: length 14.1 Spot: $D < 0.25$ is acceptable $0.25 \leq D \leq 0.4$ 2dots are acceptable and the distance between defects should more than 10 mm. $D > 0.4$ is unacceptable 14.2 Dent: $D > 0.40$ is unacceptable 14.3 Scratch: $W \leq 0.03$, $L \leq 10$ is acceptable, $0.03 < W \leq 0.10$, $L \leq 10$ is acceptable Distance between 2 defects should more than 10 mm. $W > 0.10$ is unacceptable.									
15	PCB	15.1 No distortion or contamination on PCB terminals. 15.2 All components on PCB must same as documented on the BOM/component layout. 15.3 Follow IPC-A-600F.									
16	Soldering	Follow IPC-A-610C standard									
17	Electrical Defect (Major defect)	The below defects must be rejected. 17.1 Missing vertical / horizontal segment,									

	<p>17.2 Abnormal Display.</p> <p>17.3 No function or no display.</p> <p>17.4 Current exceeds product specifications.</p> <p>17.5 LCD viewing angle defect.</p> <p>17.6 No Backlight.</p> <p>17.7 Dark Backlight.</p> <p>17.8 Touch Panel no function.</p>
--	---

Remark: LCD Panel Broken shall be rejected. Defect out of LCD viewing area is acceptable.

10.7. Classification of Defects

- 10.7.1. Visual defects (Except no / wrong label) are treated as minor defect and electrical defect is major.
- 10.7.2. Two minor defects are equal to one major in lot sampling inspection.

10.8. Identification/marketing criteria

Any unit with illegible / wrong /double or no marking/ label shall be rejected.

10.9. Packing

- 10.9.1. There should be no damage of the outside carton box, each packaging box should have one identical label.
- 10.9.2. Modules inside package box should have compliant mark.
- 10.9.3. All direct package materials shall offer ESD protection.

Note1: Bright dot is defined as the defective area of the dot is larger than 50% of one sub-pixel area.

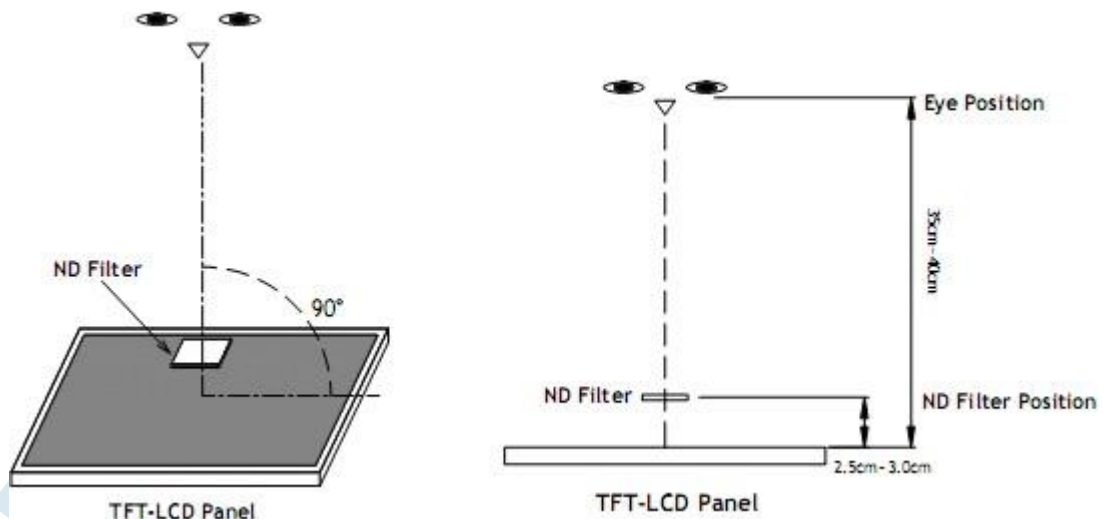

Bright dot: The bright dot size defect at black display pattern. It can be recognized by 2% transparency of filter when the distance between eyes and panel is 350mm±50mm.

Dark dot: Cyan, Magenta or Yellow dot size defect at white display pattern. It can be recognized by 5% transparency of filter when the distance between eyes and panel is 350mm±50mm.

Note2: Mura on display which appears darker / brighter against background brightness on parts of display area.

11. Reliability Specification

No	Item	Condition	Quantity	Criteria
1	High Temperature Operating	70°C, 96Hrs	2	GB/T2423.2-2008
2	Low Temperature Operating	-20°C, 96Hrs	2	GB/T2423.1-2008
3	High Humidity	50°C, 90%RH, 96Hrs	2	GB/T2423.3-2016
4	High Temperature Storage	80°C, 96Hrs	2	GB/T2423.2-2008
5	Low Temperature Storage	-30°C, 96Hrs	2	GB/T2423.1-2008
6	Thermal Cycling Test	-20°C, 60min~70°C, 60min, 20 cycles.	2	GB/T2423.22-2012
7	Packing vibration	Frequency range:10Hz~50Hz Acceleration of gravity:5G X, Y, Z 30 min for each direction.	2	GB/T5170.14-2009
8	Electrical Static Discharge	Air: ±8KV 150pF/330 Ω 5 times Contact: ±4KV 150pF/330 Ω 5 times	2	GB/T17626.2-2018
9	Drop Test (Packaged)	Height:80 cm,1 corner, 3 edges, 6 surfaces.	2	GB/T2423.8-1995

Note1. No deflection cosmetic and operational function allowable.

Note2. Total current Consumption should be below double of initial value

12. Precautions and Warranty

12.1.Safety

- 12.1.1. The liquid crystal in the LCD is poisonous. Do not put it in your mouth. If the liquid crystal touches your skin or clothes, wash it off immediately using soap and water.
- 12.1.2. Since the liquid crystal cells are made of glass, do not apply strong impact on them. Handle with care.

12.2.Handling

- 12.2.1. Reverse and use within ratings in order to keep performance and prevent damage.
- 12.2.2. Do not wipe the polarizer with dry cloth, as it might cause scratch. If the surface of the LCD needs to be cleaned, wipe it swiftly with cotton or other soft cloth soaked with petroleum IPA, do not use other chemicals.

12.3.Storage

- 12.3.1. Do not store the LCD module beyond the specified temperature ranges.
- 12.3.2. Strong light exposure causes degradation of polarizer and color filter.

12.4.Metal Pin (Apply to Products with Metal Pins)

12.4.1. Pins of LCD and Backlight

12.4.1.1. Solder tip can touch and press on the tip of Pin LEAD during the soldering

12.4.1.2. Recommended Soldering Conditions

Solder Type: Sn96.3~94-Ag3.3~4.3-Cu0.4~1.1

Maximum Solder Temperature: 370°C

Maximum Solder Time: 3s at the maximum temperature

Recommended Soldering Temp: 350±20°C

Typical Soldering Time: ≤3s

12.4.1.3. Solder Wetting

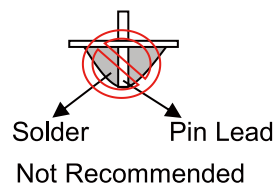
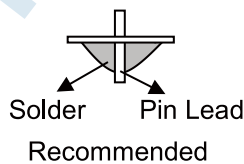

12.4.2. Pins of EL

12.4.2.1. Solder tip can touch and press on the tip of EL leads during soldering.

12.4.2.2. No Solder Paste on the soldering pad on the motherboard is recommended.

12.4.2.3. Recommended Soldering Conditions

Solder type: Nippon Alimit Leadfree SR-34, size 0.5mm

Recommended Solder Temperature: 270~290°C

Typical Soldering Time: ≤2s

Minimum solder distance from EL lamp (body):2.0mm

12.4.2.4. No horizontal press on the EL leads during soldering.

12.4.2.5. 180° bend EL leads three times is not allowed.

12.4.2.6. Solder Wetting

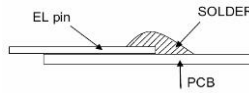

Recommended

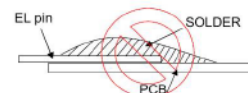

Not Recommended

12.4.2.7. The type of the solder iron:

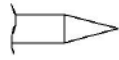

Recommended

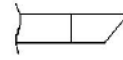

Not Recommended

12.4.2.8. Solder Pad

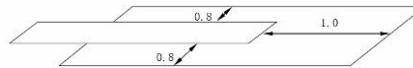

12.5. Operation

- 12.5.1. Do not drive LCD with DC voltage
- 12.5.2. Response time will increase below lower temperature
- 12.5.3. Display may change color with different temperature
- 12.5.4. Mechanical disturbance during operation, such as pressing on the display area, may cause the segments to appear “fractured”.
- 12.5.5. Do not connect or disconnect the LCM to or from the system when power is on.
- 12.5.6. Never use the LCM under abnormal condition of high temperature and high humidity.
- 12.5.7. Module has high frequency circuits. Sufficient suppression to the electromagnetic interface shall be done by system manufacturers. Grounding and shielding methods may be important to minimize the interference.
- 12.5.8. Do not display the fixed pattern for long time (we suggest the time not longer than half of one hour) because it may develop image sticking due to the TFT structure.

12.6. Static Electricity

- 12.6.1. CMOS LSIs are equipped in this unit, so care must be taken to avoid the electro-static charge, by ground human body, etc.
- 12.6.2. The normal static prevention measures should be observed for work clothes and benches.
- 12.6.3. The module should be kept into anti-static bags or other containers resistant to static for storage.

12.7. Limited Warranty

- 12.7.1. Our warranty liability is limited to repair and/or replacement. We will not be responsible for any consequential loss.
- 12.7.2. If possible, we suggest customer to use up all modules in six months. If the module storage time over twelve months, we suggest that recheck it before the module be used.
- 12.7.3. After the product shipped, any product quality issues must be feedback within three months, otherwise, we will not be responsible for the subsequent or consequential events.

13. Packaging

TBD

SOLONIC CONFIDENTIAL